

TURBINE DIGITAL METER

User's Manual



WARNING

Read carefully and understand all INSTRUCTIONS before operating.

Failure to follow the safety rules and other basic safety precautions may result in serious personal injury. Save these instructions in a safe place and on hand so that they can be read when required.

Model No.: 15221001, 15221002, 15221003, 15221004

1. INTRODUCTION

1.1 MEASUREMENT SYSTEM

1.1.1 The liquids compatible with turbine digital meter must be at low viscosity, namely:

- diesel fuel
- water
- water/urea solution
- kerosene
- windscreen

Use of other fluids may be inaccurate and can damage the meter

1.1.2 Flow Rate: 3-26GPM, flow rates outside of this range may be off.

Not suitable when used in a retail sale of diesel, oil or kerosene!

1.2 LCD DISPLAY

The "LCD" of the meter features two numerical Registers and various indications displayed to the user only when the applicable function so requires

Fig. 1

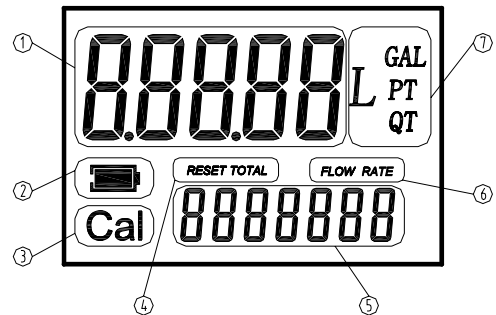

KEY

- ① Partial register (5 figures with moving comma from 0.1 to 99999)
Indicating the volume dispensed since the reset button was last pressed.
- ② Indication of battery charge
- ③ Indication of calibration mode
- ④ Indication of resetting present total to Zero
- ⑤ Total register
- ⑥ Indication of flow rate mode
- ⑦ Indication of unit of measurement of partial: L= Litres

GAL = Gallons

PT = Pints

QT = Quarts

1.3 USER BUTTONS

The turbine digital meter features two buttons (MENU and RESET) which individually perform two main functions and together, other secondary functions.

The main functions performed are:

For the reset key, resetting the partial Register and reset table total (reset total)

For the move key, entering instrument calibration mode.

Used together, the two keys permit entering configuration mode,

1.4 BATTERY REPLACEMENT

When replacing the battery, please open the cover, remove the plug and replace the battery.

2. INSTALLATION

The inlet and outlet for this meter is 1" BSP/NPT. It can be easily connected with the pipe or nozzle.

3. DAILY USE

3.1 BUTTON USAGE, CALIBRATION AND MEASUREMENT UNIT CHANGE

- **Reset the present total (See Fig. 2)**

- 1) When the meter is on standby, press the RESET key.
- 2) The display shows all the segments.
- 3) The meter resets the present total already.



Fig. 2

- **Show current correction factor and general total (See Fig. 3)**

Press MENU and RESET together and hold for two seconds.
Value "1.4000" is the correction factor which can be reset;
"1234567" is the general total which cannot be reset.



Fig. 3

- **Measurement unit change (See Fig. 4)**

Press MENU and RESET together and hold for five seconds.

Zone 7 on the display is the current unit. Press RESET to chose a different measurement unit and then press MENU to confirm.

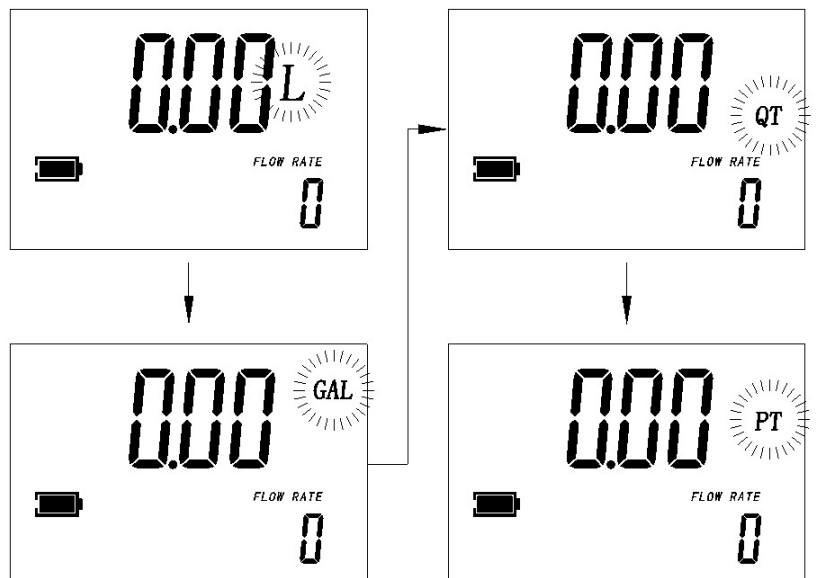

Fig. 4

3.2 RESET THE RESETTABLE TOTAL (SEE FIG. 5)

When the meter is on standby, press the RESET key for 2 seconds to reset the present total first.

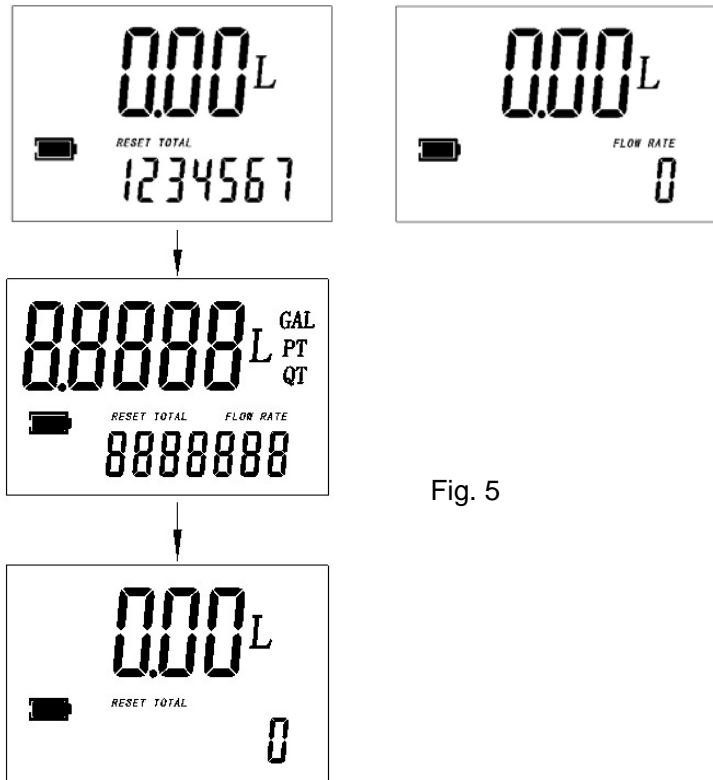

Fig. 5

3.3 PROCEDURE FOR ENTER THE CORRECTION FACTOR DIRECTLY





Carefully follow the procedure indicated below.

FORMULA

$$\text{Proper correction factor} = \text{current correction factor} \times (\text{actual value} / \text{display value})$$



Example:





Actual value	20.75
Display value	18.96
Current correction factor	1.000
Proper correction factor	$1.000 \times (20.75 / 18.96) = 1.000 \times 1.094 = 1.094$

1	Wait for the meter to go to standby.	
2	Reset the resettable total.	
3	Press the MENU key. Keep it pressed until similar with the image showed (the digit flash in ① zone), it means the meter is in correction factor modification mode.	
4	Press the RESET key to choose the right digit from 0 to 9. Press the MENU key to start the next digit. So the digit of correction factor can be changed one by one.	
5	Make sure the correction factor is right, press the MENU key. Keep it pressed until quit calibration mode, the factor is saved. The meter goes to standby again.	

3.4 MODIFY THE CORRECTION FACTOR IN FIELD

PLEASE CAREFULLY FOLLOW THE PROCEDURE INDICATED BELOW.

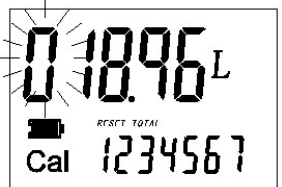
1	Wait for the meter to go to standby.	
2	Reset the resettable total.	

3	<p>Start dispensing into a measuring glass.</p>  <p>Stop dispensing when over 5 Litres of volume is reached, read out the actual value. The volume that is displayed on the LCD is the Display Value, not the Actual Value which may be slightly higher. For example, in the figure on the right, the Display Value is 18.96 while the Actual Value is 20.75.</p>	
4	<p>Press the MENU key. Keep it pressed until showed as the right fig., the digit flash in ① zone, Press the RESET key to choose the right digit from 0 to 9. Press the MENU key to go the the next digit so that the Actual Value can be input.</p>	 
5	<p>Make sure the correction factor is right and then press the MENU key. Keep it pressed until calibration is finished and the factor is save. The meter will then return to standby.</p>	

4. MALFUNCTIONS

Problem	Possible Cause	Corrective Action
LCD: no indication	Bad battery contact	Check battery contacts
Imprecise measurement	Wrong FACTOR	With reference to paragraph 3.3 & 3.4, check the FACTOR
	The meter works below minimum acceptable flow rate	Increase the flow rate until an acceptable flow rate range has been achieved
Reduced or zero flow rate	Turbine blocked	Clean the turbine
The meter does not count, but the flow rate is correct	Incorrect installation of gears after cleaning	Repeat the reassembly process.
	Possible electronic card problems	Contact Northern Tool + Equipment

5. DIAGRAM AND PARTS LIST

#15221001, 15211003

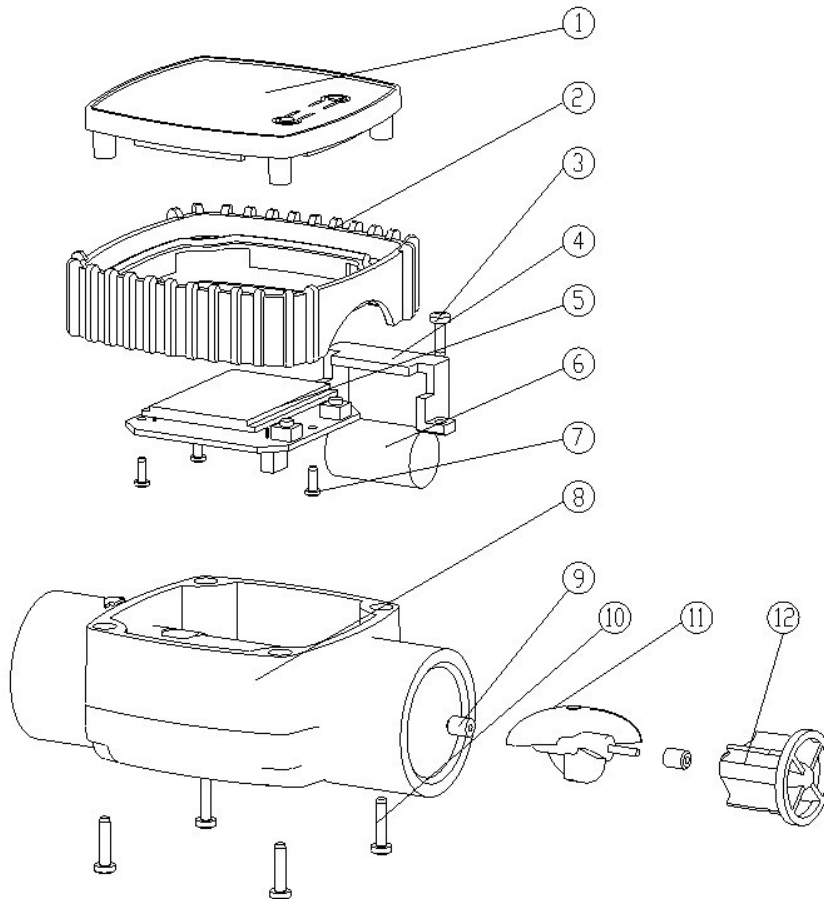

No	Description	Qty.
1	Meter Cover	1
2	Rubber Protection	1
3	Self-tap screw ST2.9X9.5	2
4	Battery Holder	1
5	Electric Board	1
6	Battery CR2	1
7	Self-tap screw ST2.2X6.5	3
8	Meter body	1
9	Bearing	2
10	Self-tap screw ST2.9X13	4
11	Turbine	1
12	Bearing Holder	1

#15221002, 15221004

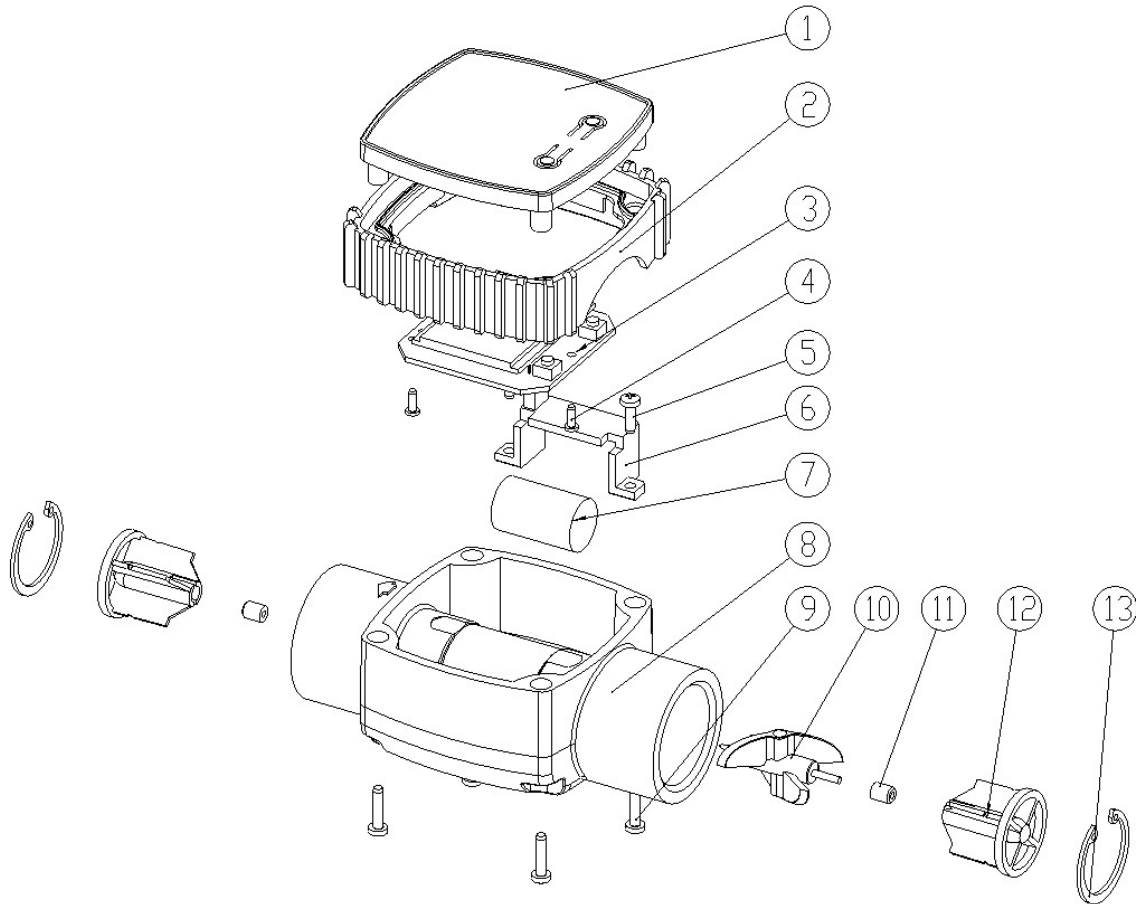

No	Description	Qty.
1	Meter Cover	1
2	Rubber Protection	1
3	Electric Board	2
4	Self tap screw ST2.9X6.5	3
5	Self tap screw ST2.2X9.5	2
6	Battery Holder	1
7	Battery CR2	1
8	Meter Body	1
9	Self tap screw ST2.9X13	4
10	Turbine	1
11	Bearing	2
12	Bearing holder	2
13	Snap Ring	2